

Lab Model
0323/0523

0823/1023

Model 0323 Series (Vacuum Model)

25.0 inHg max. vacuum
3.2 CFM open flow

0323 Lab Model (Vacuum or Pressure)

Specially accessorized for laboratory use
25.0 inHg max. vacuum or 10 psi max. pressure
3.2 CFM open flow

Model 0523 Series (Vacuum Model)

26.5 inHg max. vacuum
4.5 CFM open flow

0523 Lab Model (Vacuum or Pressure)

Specially accessorized for laboratory use
26.0 inHg max. vacuum or 10 psi max. pressure
4.5 CFM open flow

Model 0823 Series (Vacuum Model)

26.5 inHg max. vacuum
8.0 CFM open flow

Model 1023 Series (Vacuum Model)

26.5 inHg max. vacuum
0.0 CFM open flow

Includes

- Foot support assembly AC136 (0323/0523) – Vacuum models
- Thermal protector (on Single Phase Units only)
- Oiler assembly AA930A (0323/0523) – Vacuum models
- Constant level oiler AD125K (0823/1023)
- Oil reservoir AD117 (0823/1023)
- Filter V400G (0323/0523), AB599 (0823/1023)
- Muffler V425K (0323/0523), AB599C (0823/1023)

Lab Models:

- Gauges – Vacuum AA640, Pressure AA644B
- Hose barbs AA254D
- Regulators AA986A
- Carrying handle AC174
- Cord with on/off switch AA896
- Foot support assembly AC136
- Muffler AB609B
- Filter AB609D
- Oiler assembly AA930B

Recommended Accessories

- Vacuum relief valve AA840A
- Vacuum gauge AA640
- Oil AD220
- Repair kit K485 (0323/0523) – Vacuum models
- Repair kit K486 (0823/1023)
- Repair kit K556 (0323/0523) – Lab models

Product Dimensions (inches, mm)

Dimensions are for reference only

Models 0323/0523

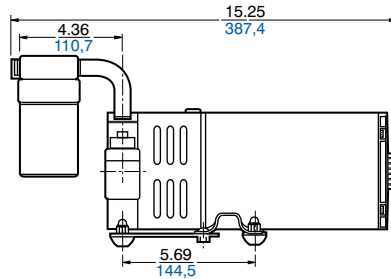
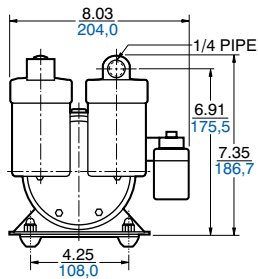

Models 0823/1023

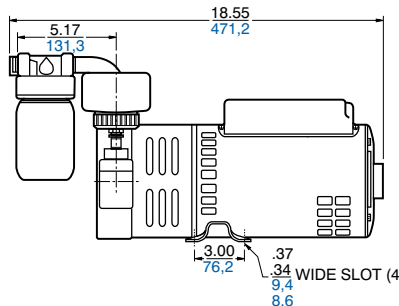
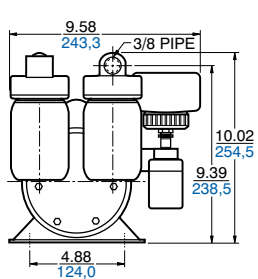

Lab Models 0323/0523

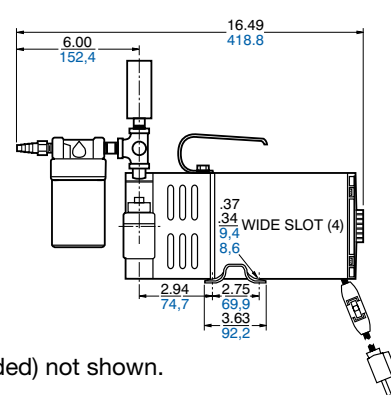
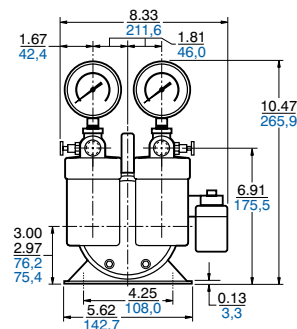

Note: Foot assembly (included) not shown.

Product Specifications

Note: All models listed below are vacuum models only except for the V4 (lab models) which are set up for vacuum or pressure.

Model Number	Motor	RPM		HP	kW	Thermal Protector	Foot Assy.	Net Weight	
		60 cycle	50 cycle					lbs	kg
0323-V3-SG588DX	100-110/220-240; 100-115/208-230-50/60-1	1725	1425	1/4	0,19	•	•	33	14,9
0323-V4-SG588DX*	100-110/220-240; 100-115/208-230-50/60-1	1725	1425	1/4	0,19	•	•	35	15,8
0523-V3-SG588DX	100-110/220-240; 100-115/208-230-50/60-1	1725	1425	1/4	0,19	•	•	33	14,9
0523-V803-G588DX*	110-120/220-240-50/60-1	1725	1425	1/4	0,19	•	•	34	15,3
0523-V4-SG588DX*	100-110/220-240; 100-115/208-230-50/60-1	1725	1425	1/4	0,19	•	•	35	15,8
0823-V2-SG608X	100-110/220-240; 100-115/208-230-50/60-1	1725	1425	3/4	0,56	•	•	54	24,3
1023-V2-SG608X	100-110/220-240; 100-115/208-230-50/60-1	1725	1425	3/4	0,56	•	•	54	24,3
1023-V2-G279	208-220/440-50/60-3	1725	1425	3/4	0,56			54	24,3

*Lab Models

Product Performance

Vacuum Models

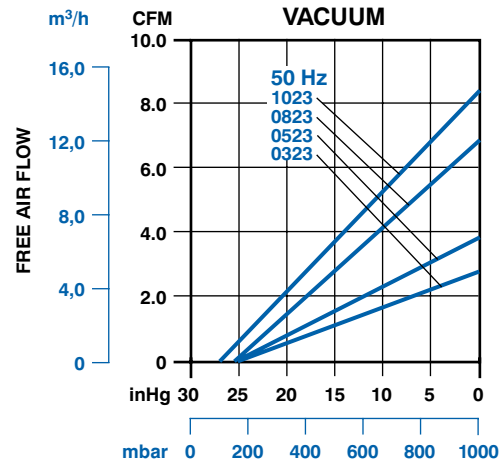
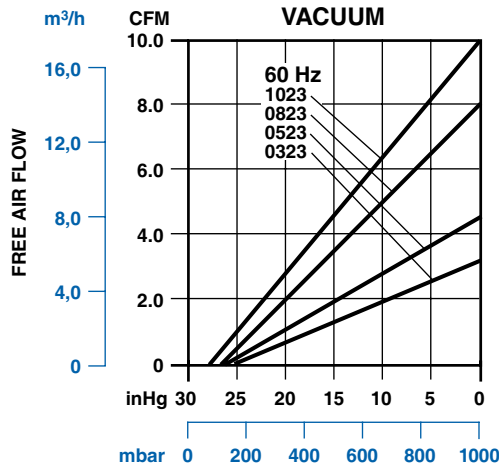

Lab Models

Note: Performance shown is for operation as a vacuum pump or compressor, not combined.

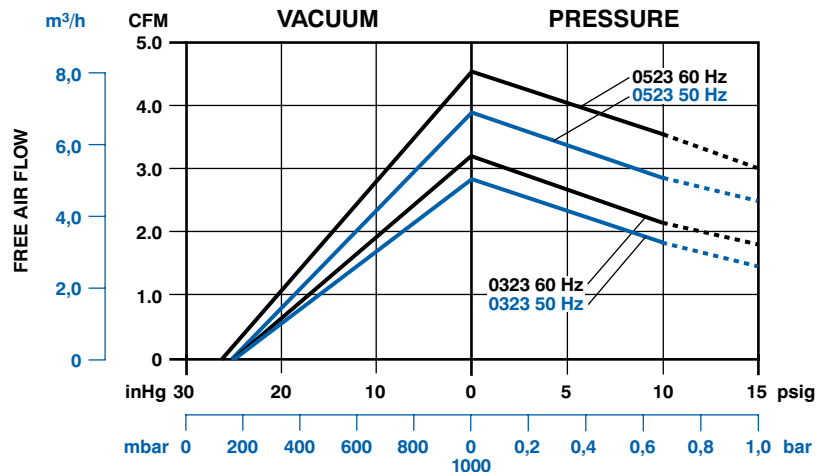



0323/0523

Model 0323 Series

- 25 inHg max. vacuum
- 3.2 CFM open flow
- 10 psi max. pressure
- 3.2 CFM open flow

Model 0523 Series

- 26 inHg max. vacuum
- 4.5 CFM open flow
- 10 psi max. pressure
- 4.5 CFM open flow

Model 0823 Series (Vacuum Model)

- 26 inHg max. vacuum
- 8.0 CFM open flow
- 10 psi max. pressure
- 8.0 CFM open flow

Model 1023 Series

- 26 inHg max. vacuum
- 10.0 CFM open flow
- 10 psi max. pressure
- 10.0 CFM open flow

Model 1423 Series

- 25 inHg max. vacuum
- 13.2 CFM open flow
- 10 psi max. pressure
- 13.5 CFM open flow

Product Features

- Oilless operation
- Motor mounted
- Rugged construction/low maintenance
- Essentially pulse-free service

Includes

- Thermal protector (on Single Phase Units only)
- Internal muffler and filter
- External muffler and filter (1423 Model)
- Silencer:
 - AK840A (0323)
 - AK840 (0523/0823/1023)
 - AC432 (1423 Models)
- Foot support assembly AC136 (0323/0523)

Recommended Accessories

- Vacuum relief valve AA840A (0523/0823/1023/1423)
- Pressure relief valve AA600
- Vacuum gauge AA640
- Repair kit K478 (0323/0523)
- Repair kit K479 (0823/1023)
- Repair kit K575A (1423)

Product Dimensions (inches, mm)

Dimensions are for reference only

Models 0323/0523

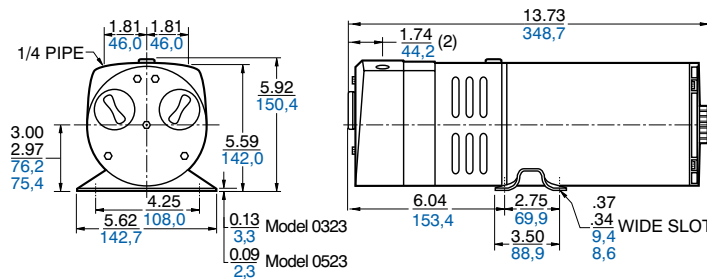

Models 0823/1023

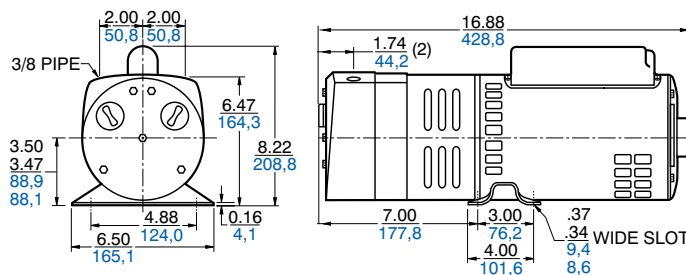

Model 1423

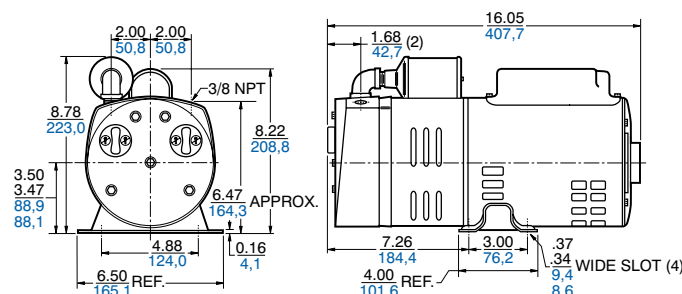

Product Specifications

Note: Models listed below are single function compressors or vacuum pumps except for D101Q models, which are dual function.

Model Number	Motor	RPM		HP	kW	Thermal Protector	Foot Assy.	Net Weight	
		60 cycle	50 cycle					lbs	kg
0323-101Q-SG588DX	100-110/220-240; 100-115/208-230-50/60-1	1725	1425	1/4	0,19	•	•	31	14,0
0523-101Q-SG588DX	100-110/220-240; 100-115/208-230-50/60-1	1725	1425	1/4	0,19	•	•	30	13,5
0523-V103-SG588DX	100-110/220-240; 100-115/208-230-50/60-1	1725	1425	1/4	0,19	•	•	30	13,5
0523-703Q-G588DX	110-120/220-240-50/60-1	1725	1425	1/4	0,19	•	•	32	14,4
0823-101Q-G279	208-220/440-60/50-3	1725	1425	3/4	0,56			47	21,2
0823-101Q-SG608X	100-110/220-240; 100-115/208-230-50/60-1	1725	1425	3/4	0,56	•		47	21,2
0823-V103-SG608X	100-110/220-240; 100-115/208-230-50/60-1	1725	1425	3/4	0,56	•		47	21,2
1023-101Q-SG608X	100-1210/220-240; 100-115/208-230-50/60-1	1725	1425	3/4	0,56	•		47	21,2
1023-101Q-G279	208-220/440-50/60-3	1725	1425	3/4	0,56			47	21,2
1023-703Q-G279	208-220/440-50/60-3	1725	1425	3/4	0,56			52	23,4
1023-V103-SG608X	100-110/220-240; 100-115/208-230-50/60-1	1725	1425	3/4	0,56	•		47	21,2
1023-703Q-ER80*	220-240/380-440-50/60-3 IP44	1725	1425	3/4	0,56			48	21,6
1423-101Q-G626X	100-110/200-220-240; 100-115/200-208-230-50/60-1	1725	1425	1	0,75	•		53	23,9
1423-101Q-G625	220-240-380-415; 230/460-50/60-3	1725	1425	1	0,75			53	23,9

Product Performance

